

Architettura Tecnica (6CFU)

Prof. Alberto De Capua, coll. Arch. Valeria Ciulla, arch. Lidia Errante, arch. Valentina Palco

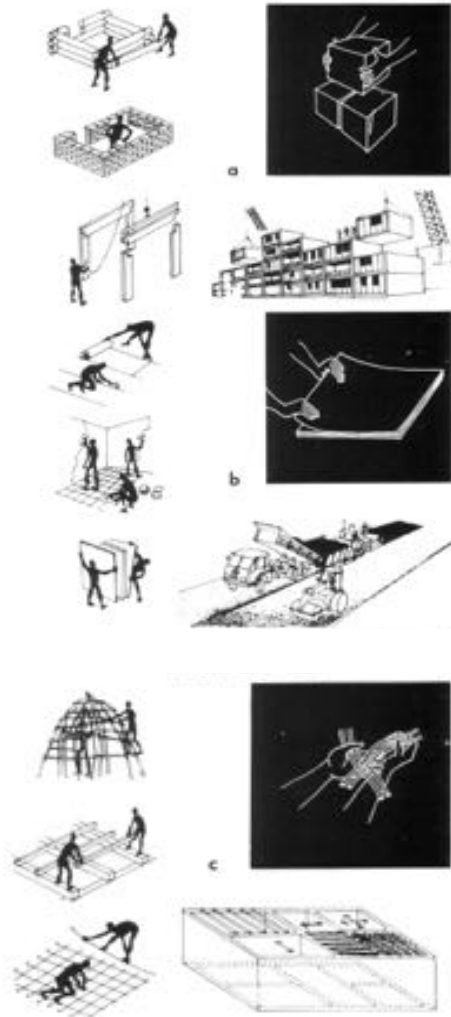

AT 5 I principi e i procedimenti costruttivi

Il processo costruttivo

L' **ORGANISMO EDILIZIO** è un “apparato costruttivo” teorico.

Il **PROCESSO COSTRUTTIVO** è l' insieme delle lavorazioni necessarie per realizzare l'Organismo Edilizio.



I fattori che influenzano il **processo costruttivo** sono:

1. la lavorabilità dei materiali
2. la loro utilizzazione ai fini di garantire la *sicurezza della costruzione*
3. la loro utilizzazione ai fini del *comfort ambientale*
4. l' aspetto
5. i modi e i mezzi per attuare il procedimento



1. Lavorabilità dei materiali

I principi di lavorazione possono essere semplici o complessi.

Si definiscono **principi semplici**:

- l' *asportazione* (templi scavati nella roccia, tracce, sbancamenti, trivellazioni, gallerie)
- la *modellatura diretta* (vetro, costruzioni in terra, piegatura tondini)
- la *modellatura indiretta* (getti di calcestruzzo, profilatura, estrusione, formatura, apparecchi igienici)

Si definiscono **principi complessi**:

- l' *addizione e stratificazione* (formazione di triliti, strutture prefabbricate)
- l' *orditura e la tessitura* (grandi coperture in legno o acciaio, ringhiere)

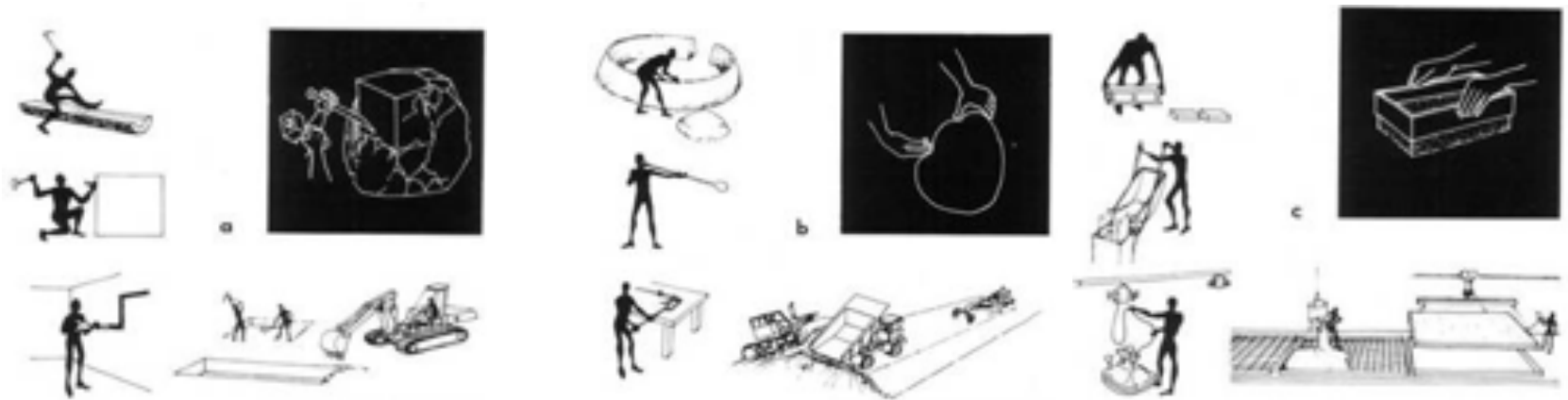

➔ 2. Utilizzazione dei materiali finalizzata alla sicurezza della costruzione

Individuazione di principi intuitivi e procedimenti analitici affinché le parti costruttive resistano alle sollecitazioni cui sono sottoposte.

Il problema presenta un duplice aspetto derivante dalla teoria della resistenza:

- esigenza di equilibrio esterno (*stabilità*)
- esigenza di equilibrio interno (*resistenza*)

Il primo dipende dai gradi di libertà degli elementi (il materiale è ininfluente).

Il secondo è in stretta relazione con le capacità di resistenza del materiale.

Principio del "trilite"

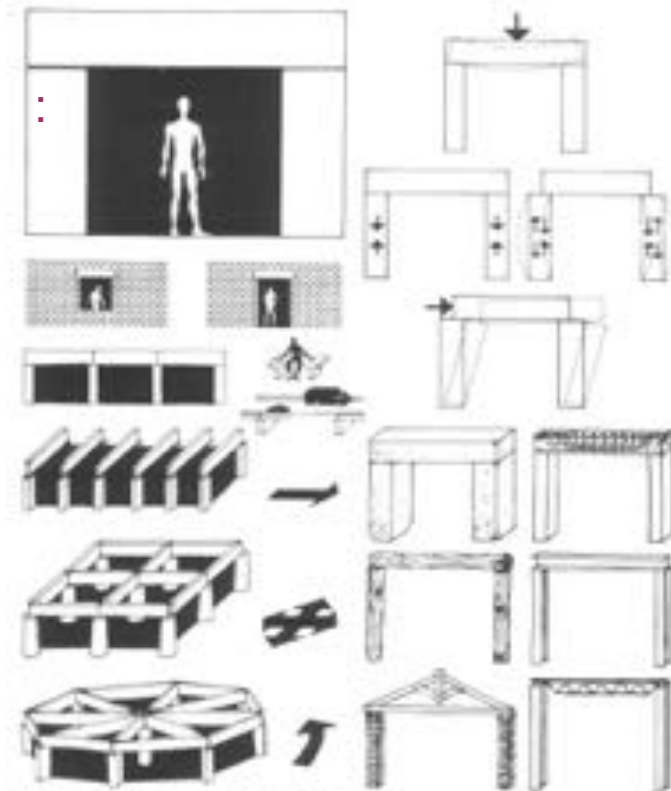

Principio del "telaio"

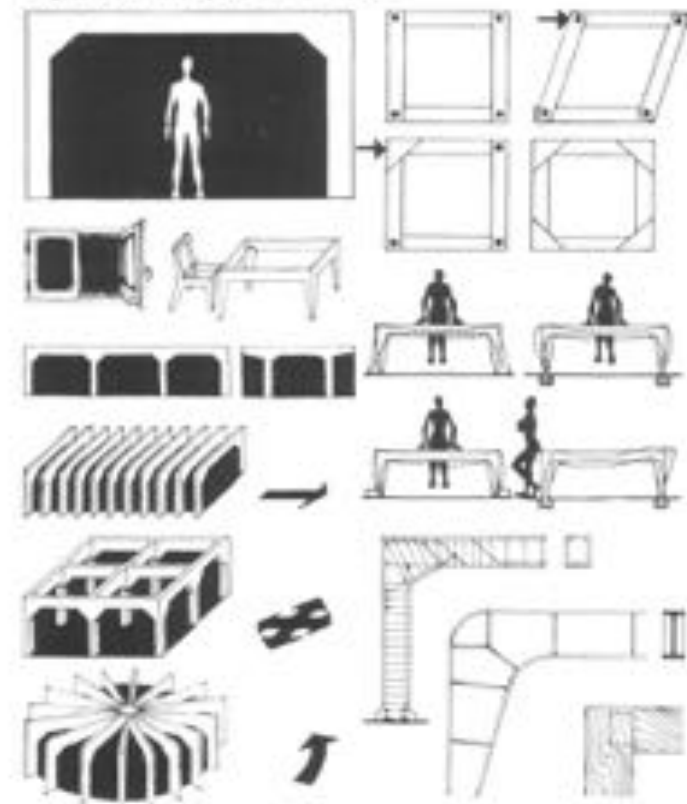

Principi complessi: il "trilite"

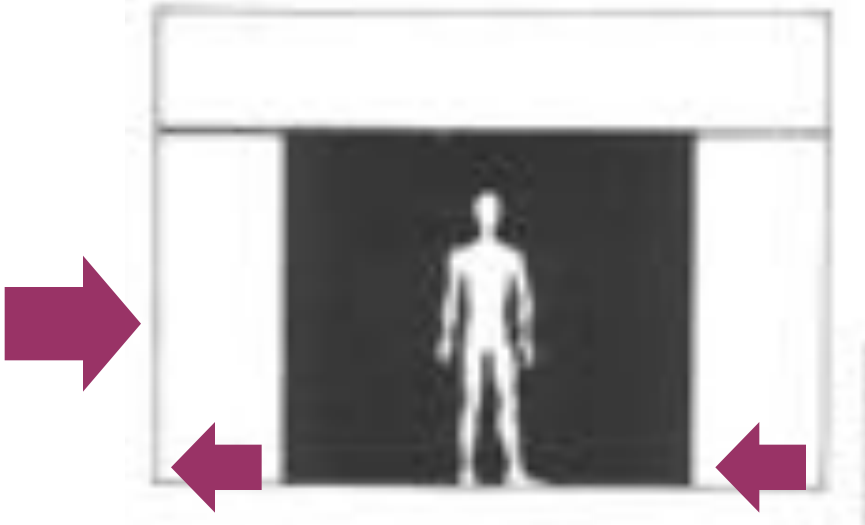
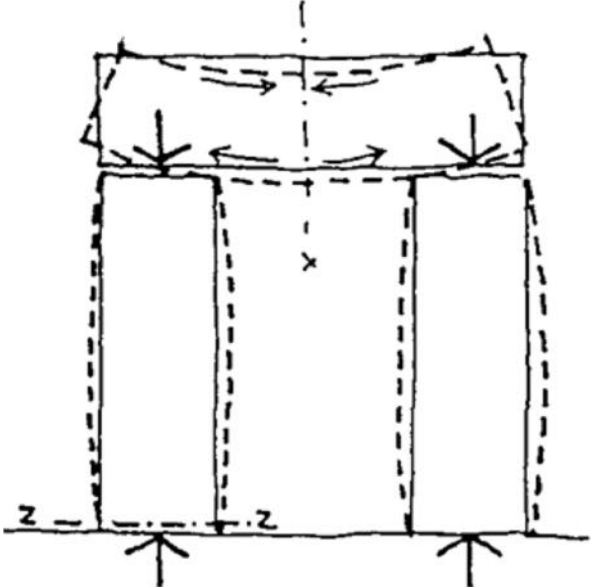

Verifica allo scorrimento

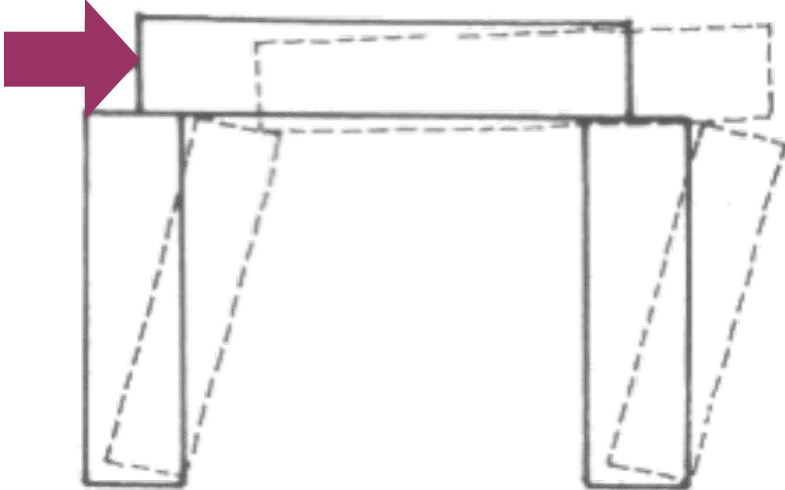

Verifica al ribaltamento

Principi complessi: il “trilite”

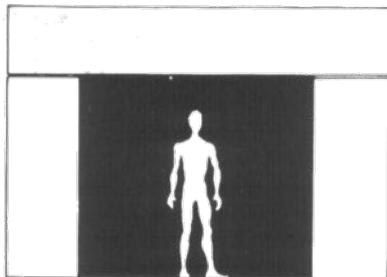

Rinforzo architrave:

1. Aumento sezione
2. Infittimento (riduz. Luce)
3. Triangolo di scarico

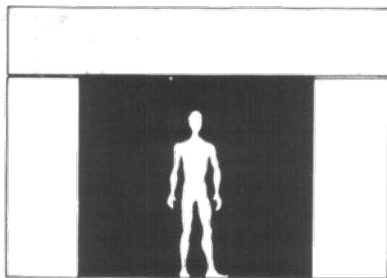
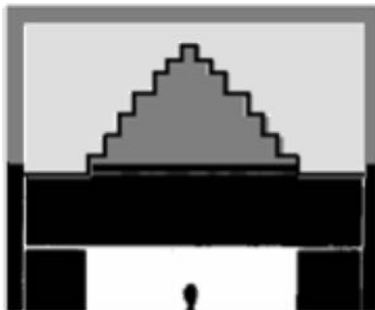
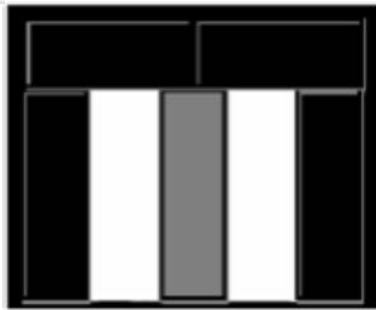

Rinforzo piedritti:

1. Aumento sezione
2. Allargamento base
3. Infittimento



Principi complessi: il "telaio"

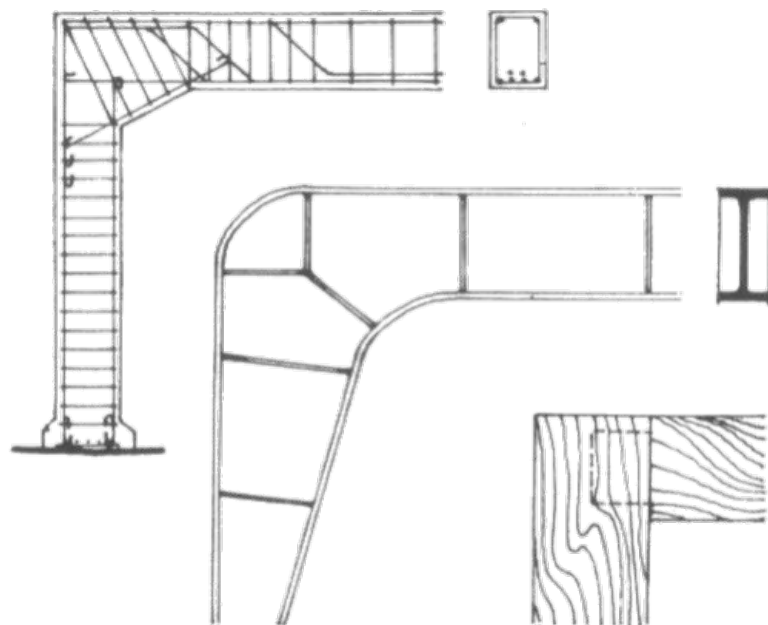
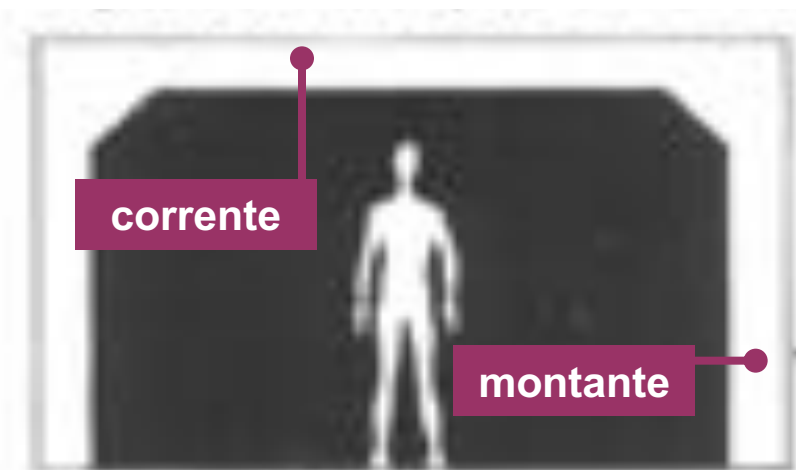

Incastri: telai in c.a., acciaio e legno



Tipi di incastro

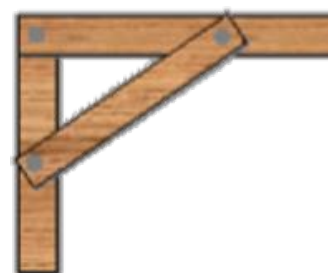
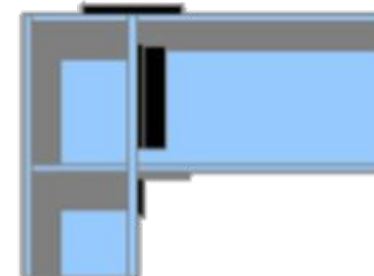

Principio dell' "arco"

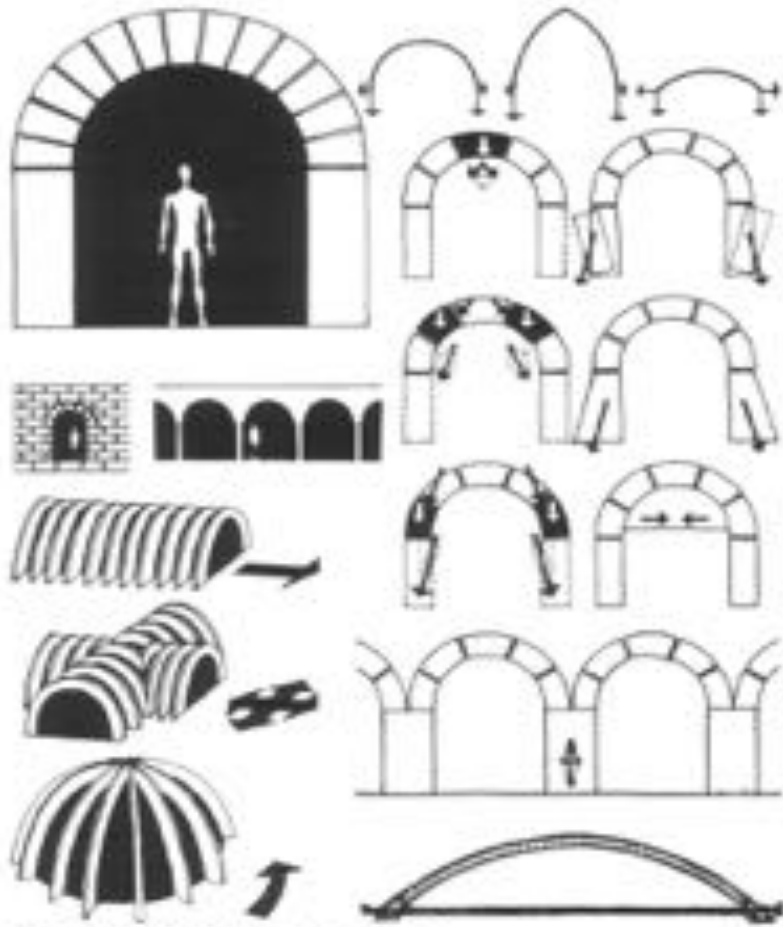

Principio del "cavo"

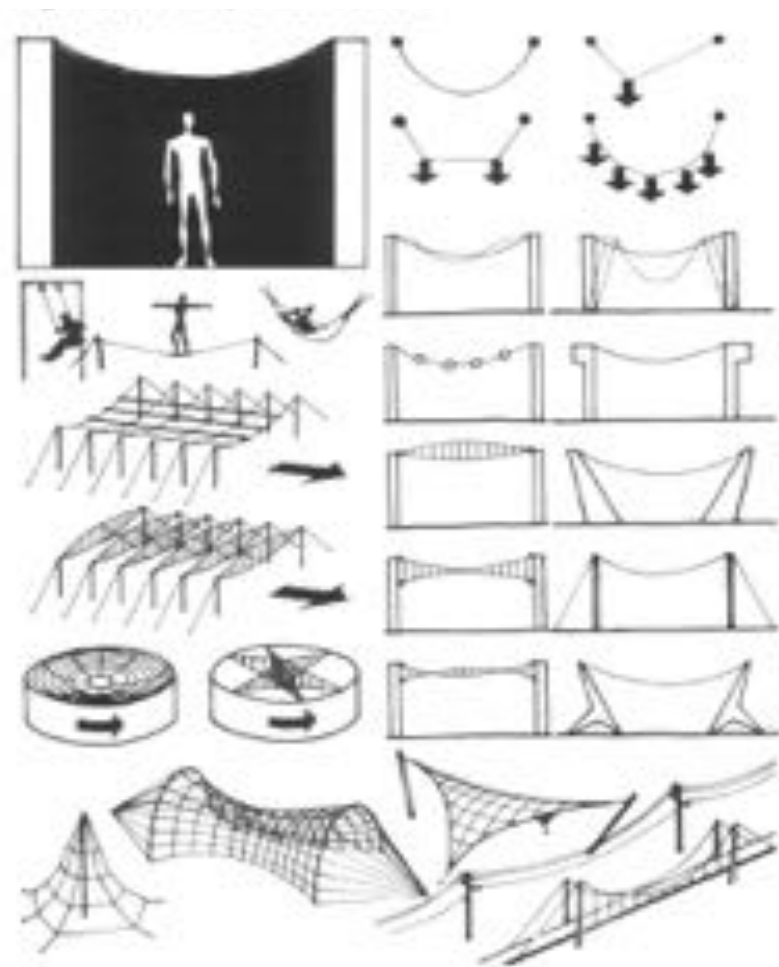

Principi complessi: l' "arco"

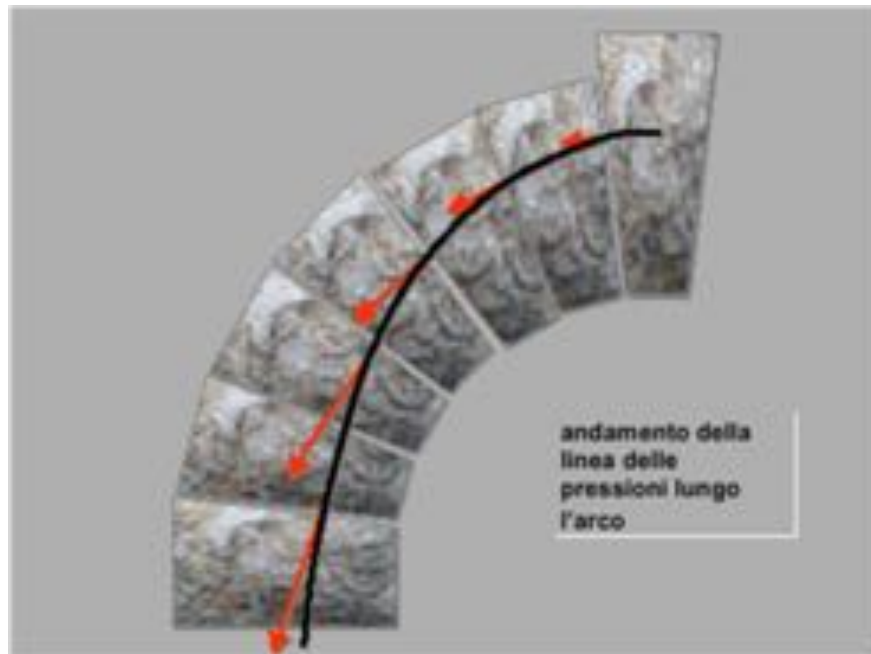
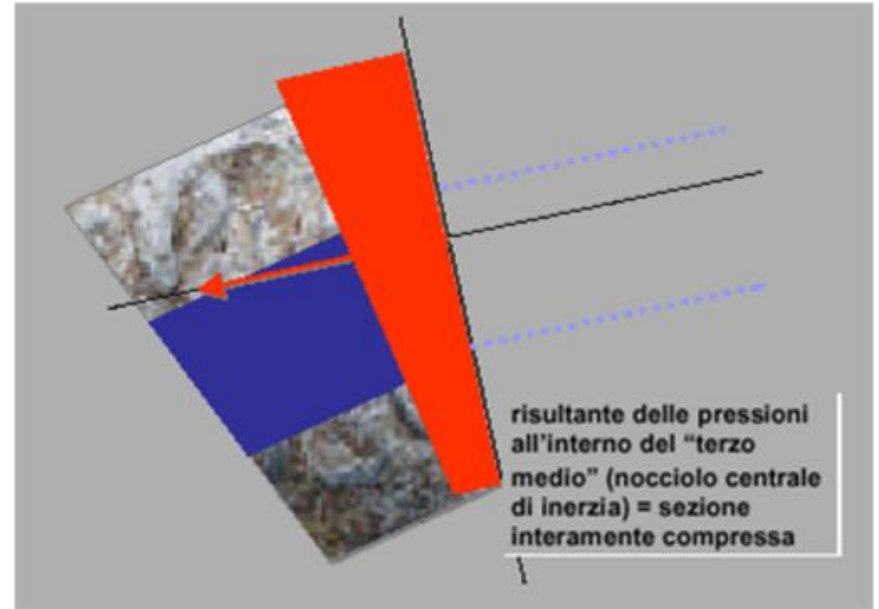
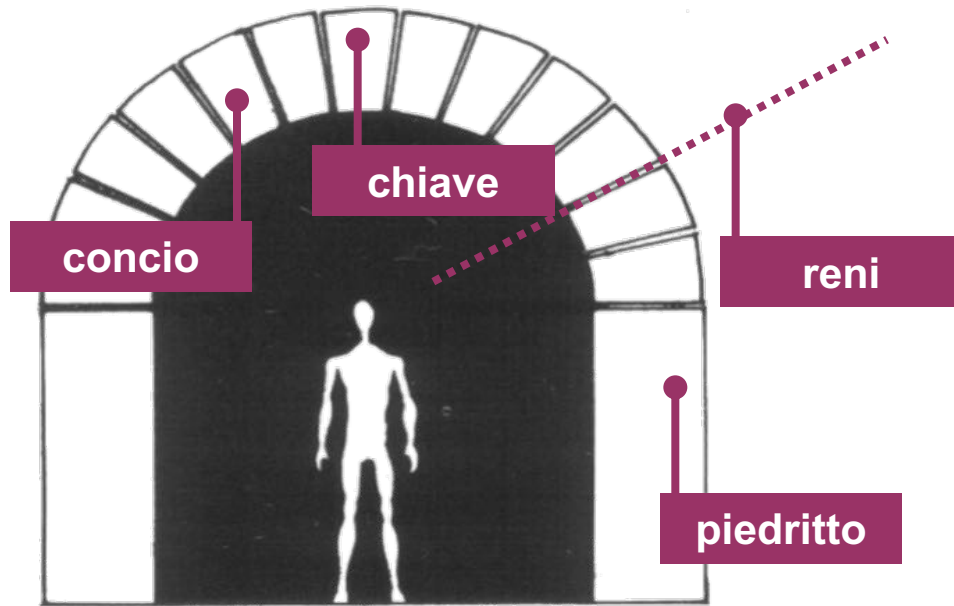

Principi complessi: I "arco"

Stabilizzazione dei piedritti

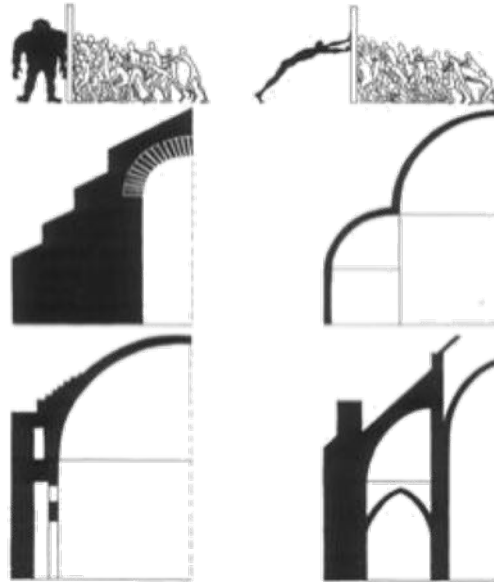
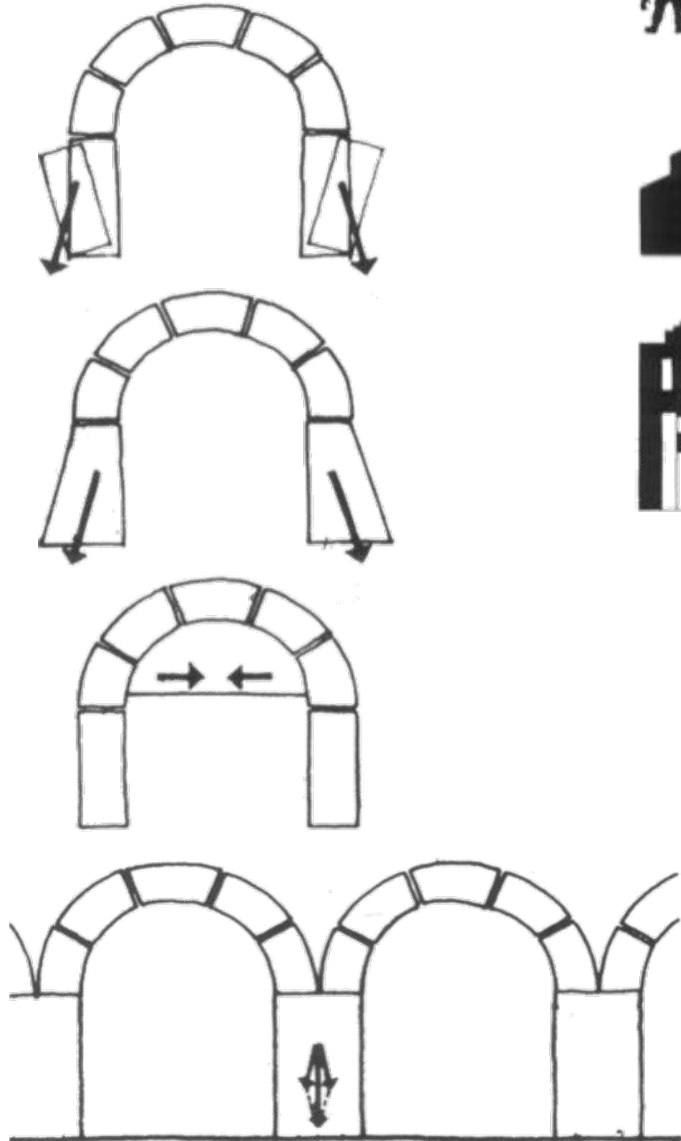

Resistenze passive e resistenze attive

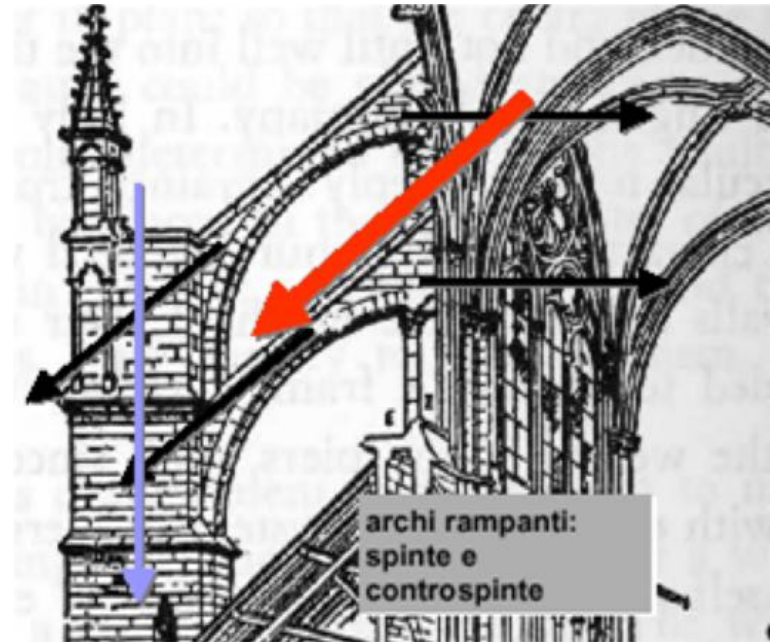

Principi complessi: il “cavo”

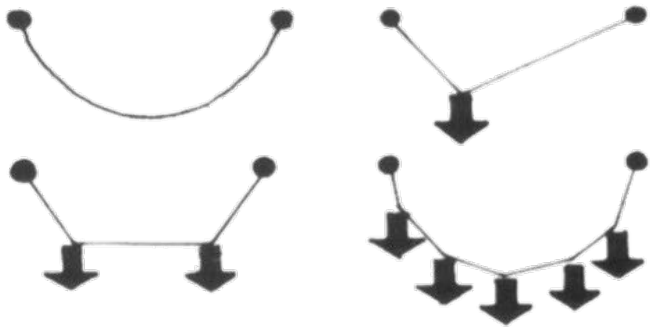

configurazione

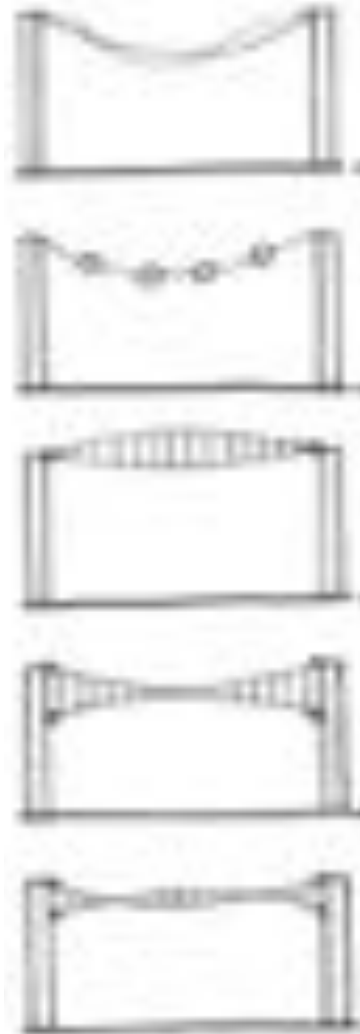

stabilizzazione

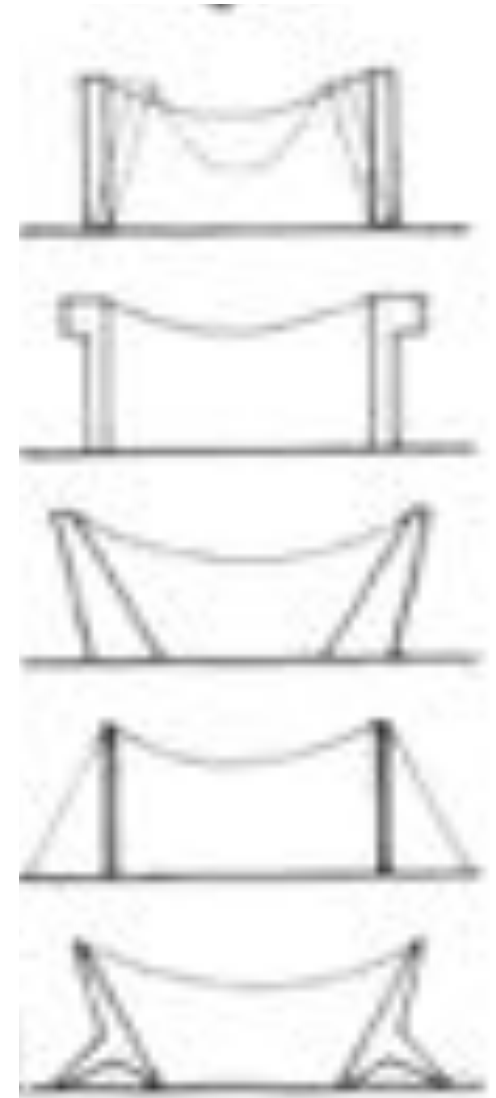

piedritti

Principi complessi: il “cavo”

Stabilizzazione dei piedritti

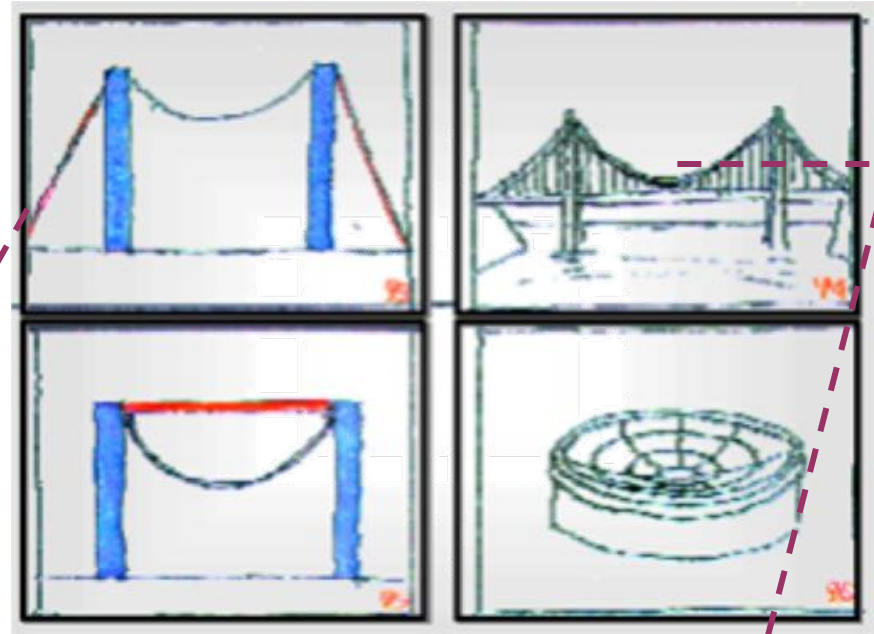
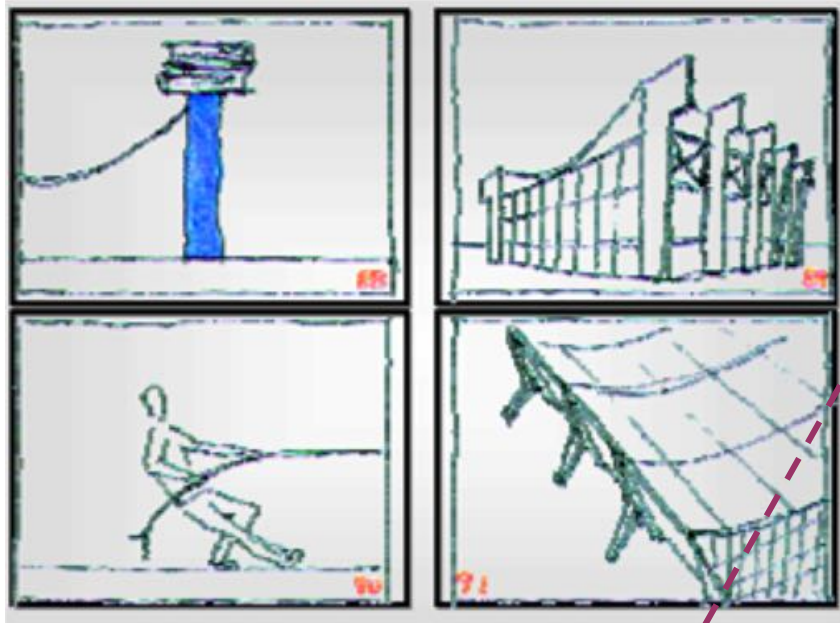

Principio del "triangolo"



Principio del "fungo"

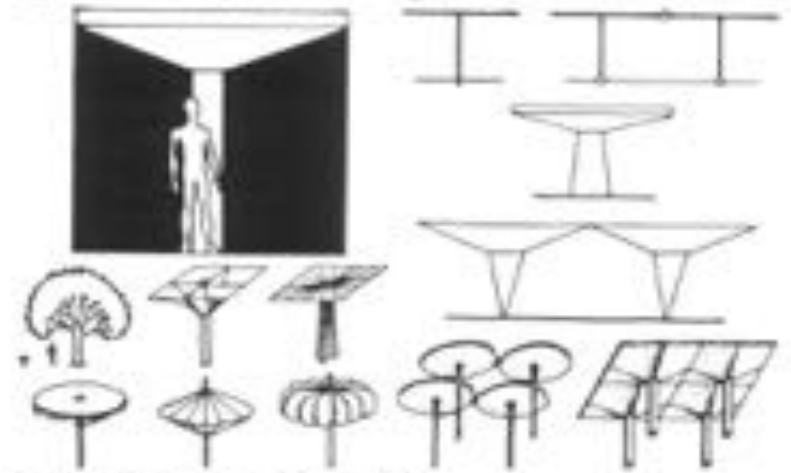

Principio dello "pneumatico"

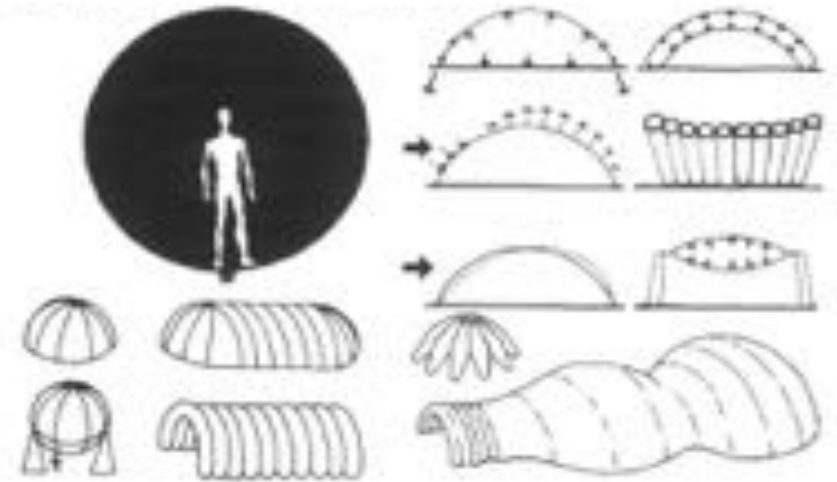

Principio del “triangolo”. Alcuni esempi

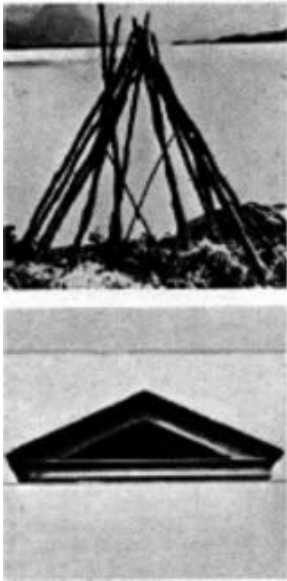

Copertura a timpano

Organismi ad involucro globale a capanna



Capriata

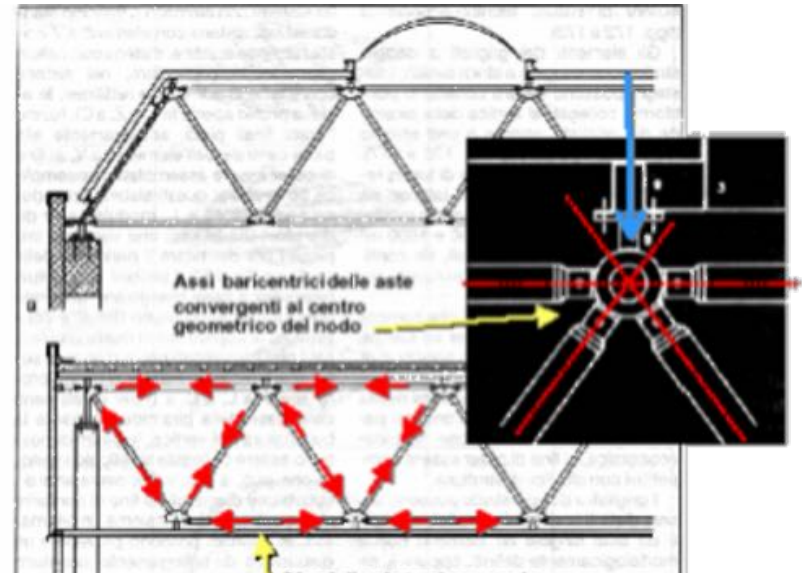

Elementi reticolari

Principio del “fungo”



Principio dello “pneumatico”

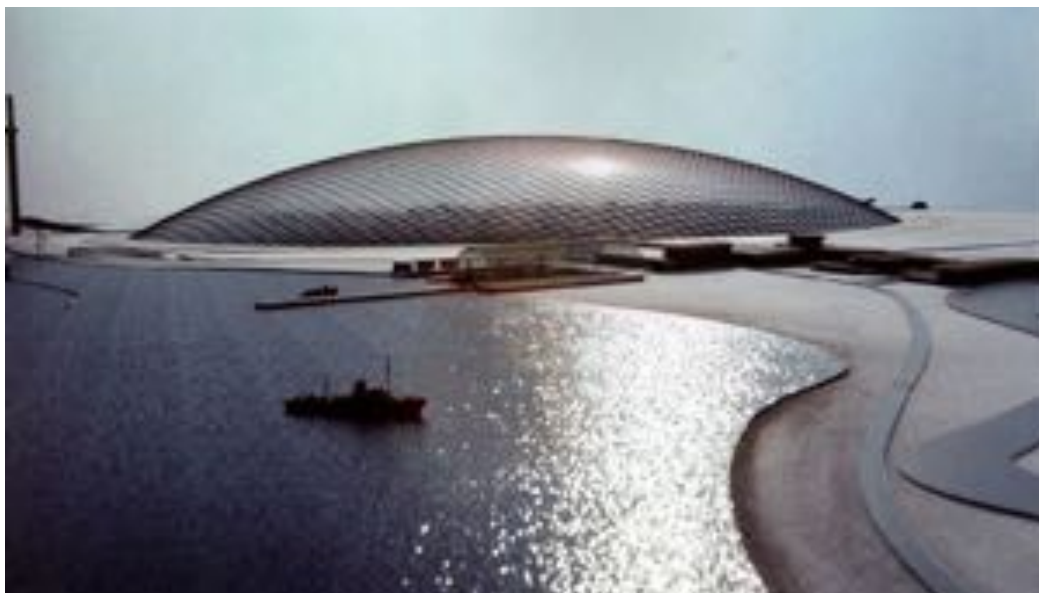

City in the Arctic, 1971, Frei Otto



Nuovo stadio di Monaco, 2006, Herzog e DeMeuron

Rapporti tra sollecitazione e deformazione



Resistenza per forma

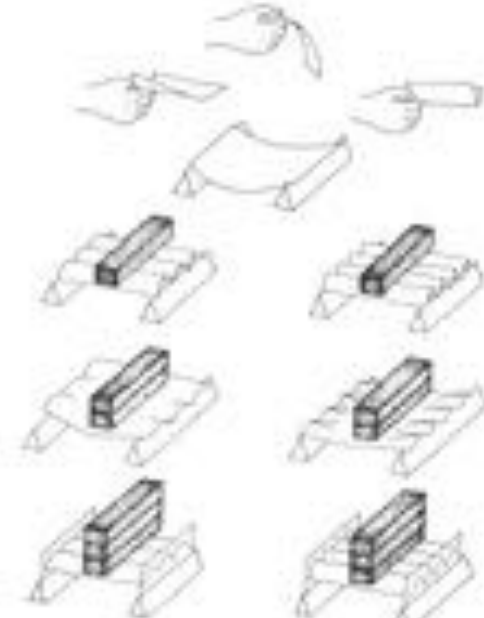

Resistenze passive e resistenze attive

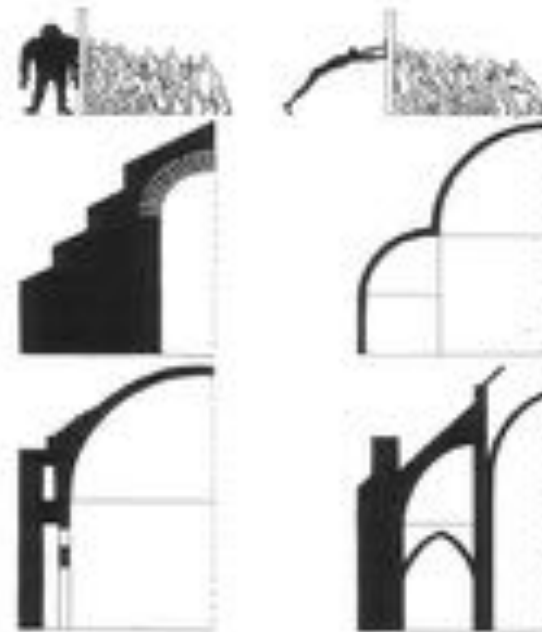



3. Utilizzazione dei materiali finalizzata al comfort ambientale

problemi di protezione dagli agenti atmosferici e di isolamento acustico

Con riferimento alla protezione dalle precipitazioni atmosferiche si distinguono due principi che incidono sulla forma dell'edificio:

- principio del **deflusso diretto** (tetto o volta)
- principio della **raccolta** e dello **smaltimento** (copertura a terrazza)

Con riferimento all'isolamento termico e acustico si distinguono:

- il principio del **corpo unico** (elemento costruttivo realizzato con un solo materiale)
- il principio del **corpo multiplo** (elementi costituiti da più materiali con ruoli complementari)

Con riferimento alla protezione da infiltrazioni d'acqua e d'aria si possono utilizzare i seguenti accorgimenti:

- ridurre il numero dei giunti
- effettuare trattamenti superficiali impermeabilizzanti
- utilizzare strati protettivi



Principio “del deflusso diretto”

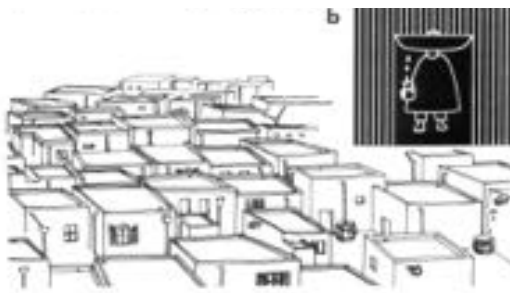

Principio “della raccolta e dello smaltimento”

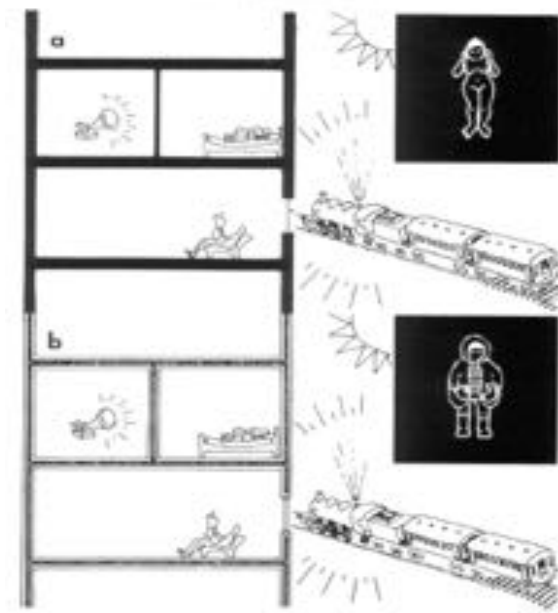

Principio “del corpo unico”

Principio “del corpo multiplo”



3. Utilizzazione dei materiali finalizzata al comfort ambientale

Assumono un importante ruolo ai fini del *comfort* anche gli impianti (riscaldamento e condizionamento, illuminazione, gas, acqua, telecomunicazione, smaltimento acque, sicurezza).

In relazione alla localizzazione delle reti e dei punti di utilizzazione si distinguono:

- impianti esterni - a vista -
- impianti interni - incorporati – (in opera, incorporabili, incorporati fuori opera).

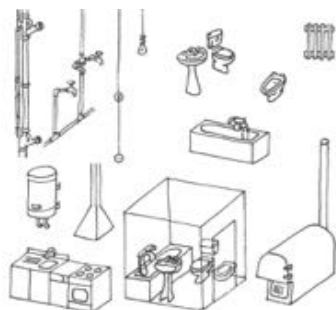

Elementi impiantistici

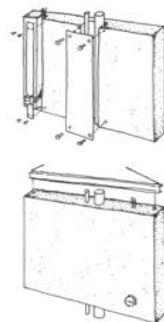
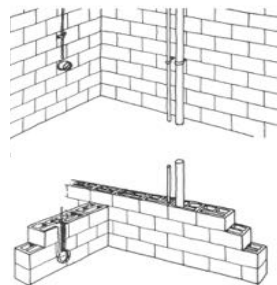

Impianti interni
incorporati fuori
opera



Impianti
interni in
opera

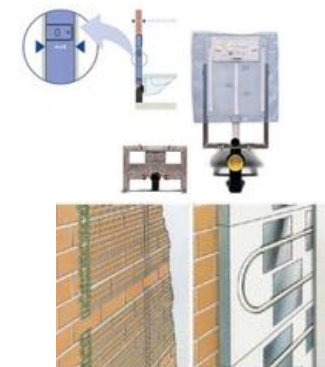

Impianti interni
incorporabili



4. Aspetto dei materiali

Si possono distinguere due principi:

1. Principio materico (elementi materiali lasciati in vista);
2. Principio geometrico (superficie e volume, uso di intonaco, vernici).

I due principi possono comunque coesistere.

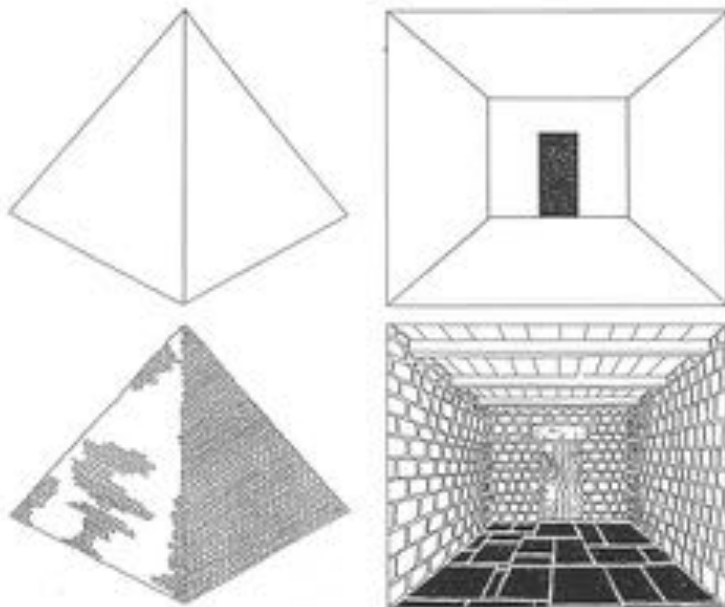

Principio geometrico e principio materico

Il materiale e la percezione della forma

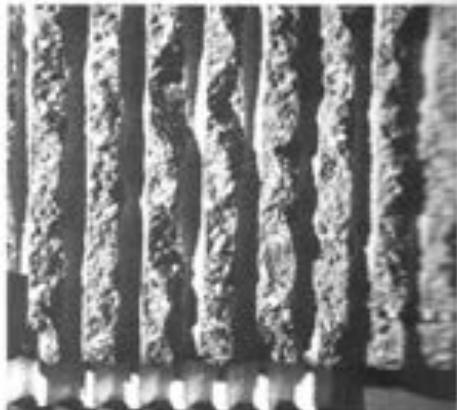

Il materiale e la percezione della forma





5. Modi e mezzi per realizzare la costruzione

- I *modi* si riferiscono all'organizzazione dei cicli di lavorazione in cantiere o in stabilimento.
 - I *mezzi* incidono direttamente sulle lavorazioni e indirettamente sulle scelte progettuali e si distinguono in mezzi manuali ed in mezzi meccanizzati.
- Il procedimento può essere *artigianale* o *industriale* e dare luogo quindi ad oggetti unici o oggetti ripetibili in serie.

